

Pizzablech

extra schwere Ausführung (Blaublech)

Art.-Nr.	oberer Ø/cm	unterer Ø/cm	Höhe/cm	€/Stück
2290 160	16	15	2,5	2,08
2290 180	18	16	2,5	2,46
2290 200	20	18	2,5	2,52
2290 220	22	20	2,5	2,72
2290 240	24	22	2,5	2,84
2290 260	26	24	2,5	3,10
2290 280	28	26	2,5	3,36
2290 300	30	28	2,5	3,62
2290 320	32	30	2,5	4,40
2291 340	34	33	2,5	5,56
2291 360	36	35	2,5	6,58
2291 400	40	39	2,5	8,64



Pizzablech - Blaublech

30 mm Aufkantung

Art.-Nr.	Abm./cm	€/Stück
2292 500	50 x 35 x 3	10,50
2292 505	50 x 50 x 3	16,30
2292 600	60 x 40 x 3	12,60
2292 606	60 x 60 x 3	21,00
2292 650	65 x 45 x 3	15,30

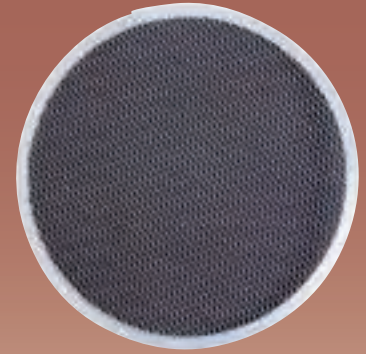

Aluminium - Pizza Screen -

Art.-Nr.	Ø/cm	€/Stück
2289 200	20	2,60
2289 220	22	2,70
2289 250	25	3,00
2289 280	28	3,20
2289 300	30	3,40
2289 330	33	3,70
2289 360	36	4,40
2289 400	40	4,70



Pizzaschaufel

aus Aluminium

Art.-Nr.	Gesamtlänge /cm	Schaufelmaß /cm	€/Stück
2293 510	51	24 x 17	10,20



Pizzaschaufel

Aluminium mit Holzgriff

Art.-Nr.	Gesamtlänge /cm	Schaufelmaß /cm	€/Stück
2293 790	79	35 x 30,5	19,90



Pizzaschaufel

18/8-18/10

Art.-Nr.	Stiellänge /cm	Blatt Ø/cm	€/Stück
2293 200	150	20	31,00
2293 300	150	30	34,20
2293 600	60	20	11,00
2293 800	80	30	16,40



Messingbürste + Stahlschaber

mit Holzgriff für Pizaofen

Art.-Nr.	Lg./cm	Br./cm	€/Stück
2295 950	95	25	14,30



Pizzaschneider mit Holzgriff

Art.-Nr.	Länge/cm	Rad Ø/cm	€/Stück
1517 240	24	9,5	3,80

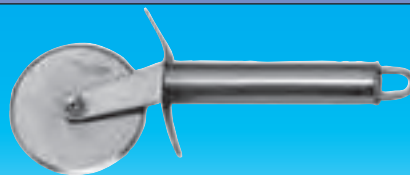

Pizzaschneider 18/8-18/10 mit Aufhängeöse

Art.-Nr.	Länge/cm	Rad Ø/cm	€/Stück
1726 065	19,5	6,5	1,60



Profi-Pizzaschneider mit schwarzem ABS-Griff

Art.-Nr.	Rad Ø/cm	Länge/cm	€/Stück
7058 240	10	24	4,00



Pizza-Schneider mit ABS-Griff einfache Ausführung

Art.-Nr.	Rad Ø/cm	€/Stück
7058 205	9,5	1,30



Pizza-Teigschneider Edeldahl-rostfrei

Art.-Nr.	Länge/cm	Höhe/cm	€/Stück
2294 560	56	13	7,90



Pizzazange verchromt extra große, schwere Ausführung

Art.-Nr.	Länge/cm	€/Stück
1517 190	19	2,40



Stiproller mit langen Stippen
ABS Griff

Art.-Nr.	Breite/cm	€/Stück
1502 001	8,5	8,30



Stiproller
extra schwere Ausführung

Art.-Nr.	Walzenbreite/cm	€/Stück
1502 125	12,5	21,90

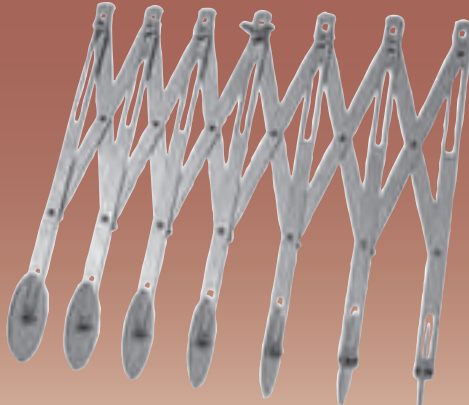

Teigschneider Edelstahl, verstellbar

Art.-Nr.	Anz./Rädchen	Höhe/cm	Ø/cm	€/Stück
1507 005	5	24,5	5,4	17,80
1507 006	6	24,5	5,4	23,20
1507 007	7	24,5	5,4	25,00



Croissant - Schneider
18/8-18/10, Griffe aus Kunststoff

Art.-Nr.	Länge/cm	Walze Ø/cm	€/Stück
2511 075	42	7,5	14,30
2511 120	42	12,0	18,00

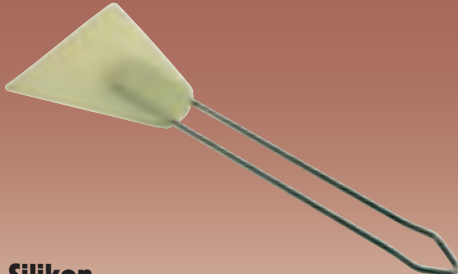

Silikon-Dreieckschaber
mit Drahtgriff

Art.-Nr.	Schaber/cm	Länge/cm	€/Stück
1541 251	9,5 x 8,0	25,0	1,60

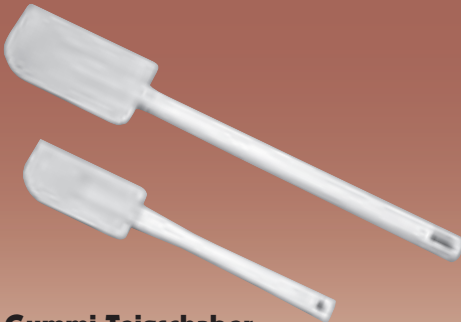

Gummi-Teigschaber
mit Plastikgriff

Art.-Nr.	Länge/cm	€/Stück
1543 250	25	1,20
1543 350	35	1,24
1543 400	40	1,36

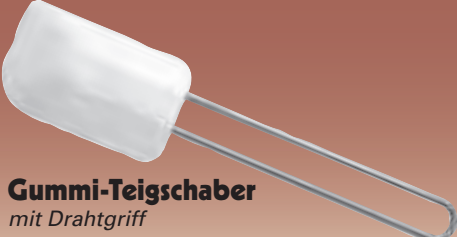

Gummi-Teigschaber
mit Drahtgriff

Art.-Nr.	Abm./cm	Gesamtlänge/cm	€/Stück
1539 270	9 x 5	27	2,30
1539 320	12 x 7	32	4,50



Teigschaber mit Holzgriff

Art.-Nr.	Größe/cm	€/Stück
7028 110	11,3 x 9,8	2,50



Teigschaber mit schwarzem ABS Griff,
schwere Ausführung

Art.-Nr.	Blattgröße/cm	€/Stück
7029 150	15 x 7,5	2,50

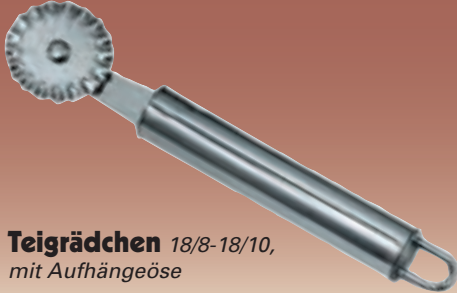

Teigrädchen 18/8-18/10,
mit Aufhängeöse

Art.-Nr.	Länge/cm	Rad Ø/cm	€/Stück
1727 037	17	3,7	1,30



Tassenbürste
mit Holzgriff

Art.-Nr.	€/Stück
3306 000	0,70



Reinigungsbürste
Holz mit Messingborsten

Art.-Nr.	Länge/cm	€/Stück
1456 300	30	1,70
1456 450	45	3,50



Tortenteiler 18/8-18/10

Art.-Nr.	Beschreibung	Ø/cm, außen	€/Stück
1501 012	12 tlg.	32	25,20
1501 014	14 tlg.	32	28,80
1501 016	16 tlg.	32	31,80



Spritzbeutel aus Nylon

Art.-Nr.	Länge/cm	€/Stück
3100 300	30	2,70
3100 350	35	3,00
3100 400	40	3,70
3100 450	45	4,50
3100 550	55	5,70
3100 600	60	6,90



Spritztüllenset mit Spritzbeutel, auf Blisterkarte

6 Spritztüllen, kleine Ausf., Chromstahl
1 Spritzbeutel 30 cm, 1 Kupplung

Art.-Nr.	€/Satz
3105 001	7,40

Kupplung für Spritztüllenset 3105 001 - 003 aus Kunststoff



Art.-Nr.	Farbe	€/Stück
3105 000	weiß	0,40

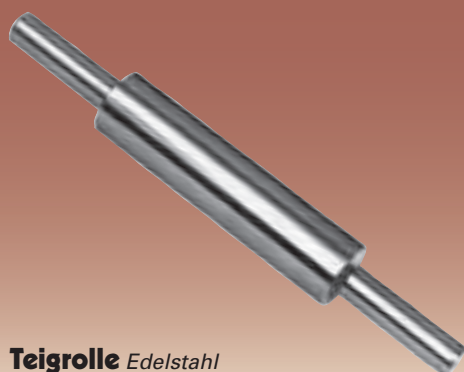

Teigrolle Edelstahl

Art.-Nr.	Länge/cm	€/Stück
1538 500	50	22,60



Sterntülle Edelstahl

Art.-Nr.	Ø/mm	Höhe/cm	€/Stück
3110 820	4	5	1,24
3110 821	6	5	1,24
3110 822	7	5	1,24
3110 823	9	5	1,24
3110 824	10	5	1,24
3110 825	12	5	1,24
3110 826	13	5	1,24
3110 827	15	5	1,24
3110 828	16	5	1,24
3110 829	18	5	1,24

Art.-Nr.	Ø/mm	Höhe/cm	Menge	€/Satz
3110 830	4 - 18	5	10 Stück	12,40

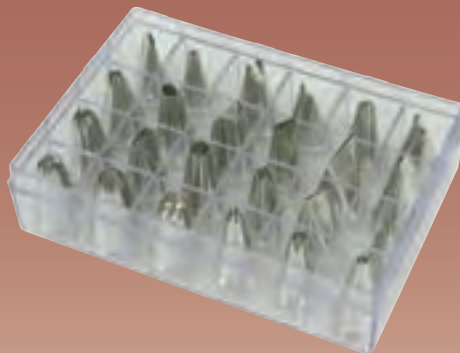

Spritztüllenset 18/8-18/10 in Klarsichtbox

Art.-Nr.	enthält	€/Satz
3105 024	24 Spritztüllen, kleine Ausführung	13,60



Lochtülle Edelstahl

Art.-Nr.	Ø/mm	Höhe/cm	€/Stück
3111 800	4	5	1,24
3111 801	6	5	1,24
3111 802	7	5	1,24
3111 803	9	5	1,24
3111 804	10	5	1,24
3111 805	12	5	1,24
3111 806	13	5	1,24
3111 807	15	5	1,24
3111 808	16	5	1,24
3111 809	18	5	1,24

Art.-Nr.	Ø/mm	Höhe/cm	Menge	€/Satz
3111 810	4 - 18	5	10 Stück	12,40



Spritztüllenset in Sortimentsbox, mit Klarsichtdeckel

Art.-Nr.	enthält	€/Satz
3105 002	26 Spritztüllen, kleine Ausf., Chromstahl, 1 Kupplung	24,90
3105 003	52 Spritztüllen, Chromstahl, 1 Kupplung	49,40

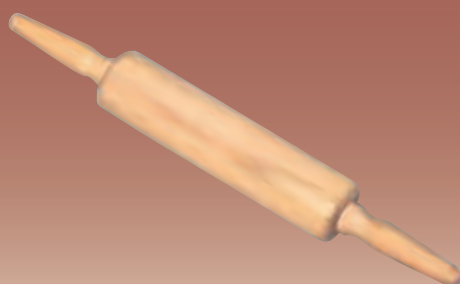

Teigrolle Holz einfache Ausführung

Art.-Nr.	Ø/cm	Breite cm/o.Griff	€/Stück
1876 250	6	25	5,10



Holz-Teigrolle mit Kugellager

Art.-Nr.	Rollenbreite/cm	€/Stück
1890 380	38	11,00
1890 450	45	13,10

Silicon Backformen mit Antihafbeschichtung, die Oberfläche muss nicht mit Fett eingerieben werden. Temperaturbereich -60°C bis $+300^{\circ}\text{C}$, auch für die Mikrowelle geeignet.

Farbe: schwarz

Abmessung: 30 x 17,5 cm

3 Stück für 1/1 GN

4 Stück für Backblech 60 x 40 cm

Reinigung: nur mit Wasser - ohne Spülmittel möglich, jedoch auch für Geschirrspüler geeignet.

Weitere Formen auf Anfrage!

Muffin

Art.-Nr.	3150 000
Ø/mm	70
Tiefe/mm	40
Anzahl Formen	6
€/Stück	18,70

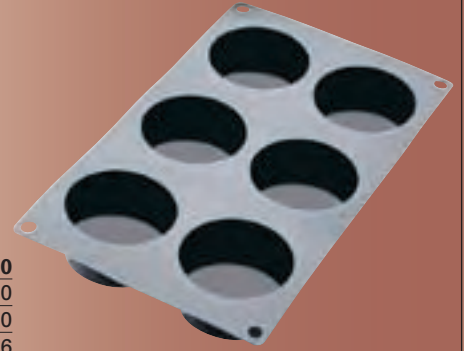

Brioche

Art.-Nr.	3150 005
Ø/mm	82
Tiefe/mm	37
Anzahl Formen	5
€/Stück	18,70

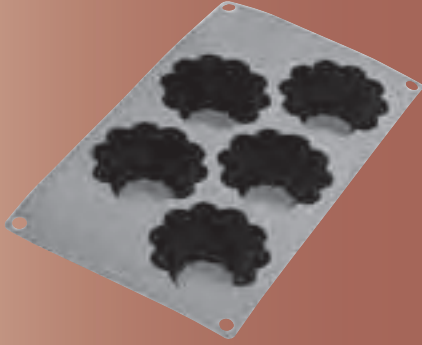

Savarin

Art.-Nr.	3150 006
Beschreibung	Savarin
Ø/mm	75
Tiefe/mm	25
Anzahl Formen	6
€/Stück	18,70

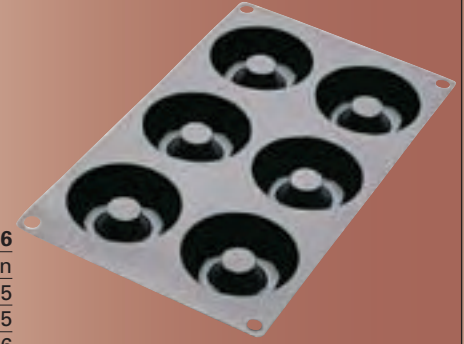

Bordelais

Art.-Nr.	3150 008
Ø/mm	56
Tiefe/mm	50
Anzahl Formen	8
€/Stück	18,70

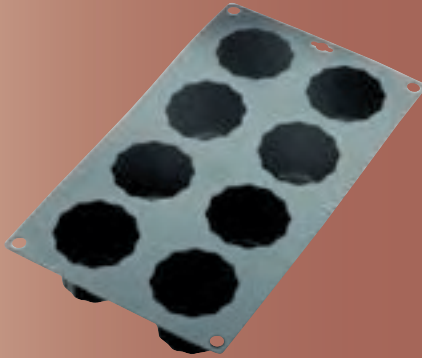

Mini - Bordelais

Art.-Nr.	3150 018
Ø/mm	35
Tiefe/mm	28
Anzahl Formen	18
€/Stück	18,70

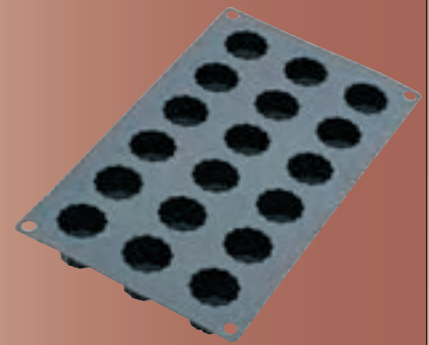

Tortelett

Art.-Nr.	3150 015
Ø/mm	50
Tiefe/mm	15
Anzahl Formen	15
€/Stück	18,70



Mini - Madeleine

Art.-Nr.	3150 024
Ø/mm	42
Tiefe/mm	12
Anzahl Formen	24
€/Stück	18,70

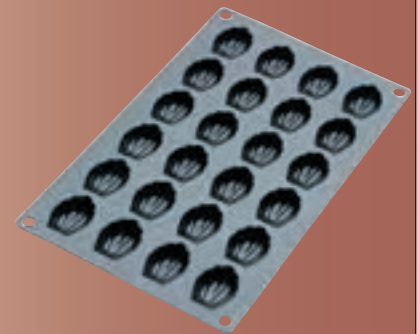

Tortenform

Art.-Nr.	3150 280
Ø/mm	280
Tiefe/mm	45
Anzahl Formen	1
€/Stück	19,50



Königskuchen

Art.-Nr.	3150 260
Länge/mm	260
Breite/mm	100
Tiefe/mm	75
Anzahl Formen	1
€/Stück	17,10

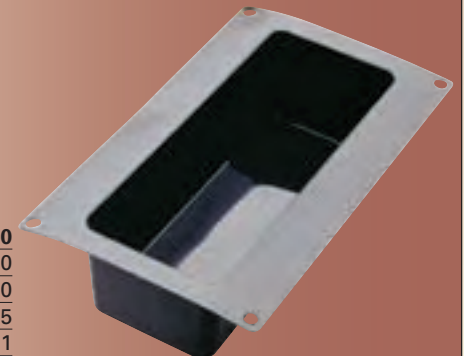

**Backformen**

mit Antihft-Beschichtung

Art.-Nr.	Beschreibung	Ø/cm	Höhe/cm	€/Stück
3120 230	Springform	23	7,5	4,00
3120 250	Springform	25	7,5	4,50
3120 270	Springform	27	7,5	5,10

Art.-Nr.	Beschreibung	Abm. Ø/cm	€/Set
3120 003	Springform	23, 25, 27	10,40

Set mit 3 Stück

**Backformen** mit Antihft-Beschichtung

Art.-Nr.	Beschreibung	Ø/cm	Höhe/cm	€/Stück
3122 250	Springform mit 2 Böden	25	7,5	7,90

**Backformen**

mit Antihft-Beschichtung

Art.-Nr.	Beschreibung	Ø/cm	Höhe/cm	€/Stück
3125 250	Bundform	25	8	8,80

**Lasagneform** mit Antihft-Beschichtung

Art.-Nr.	Länge x Breite x Höhe/cm	€/Stück
3124 330	33 x 24 x 5	6,70

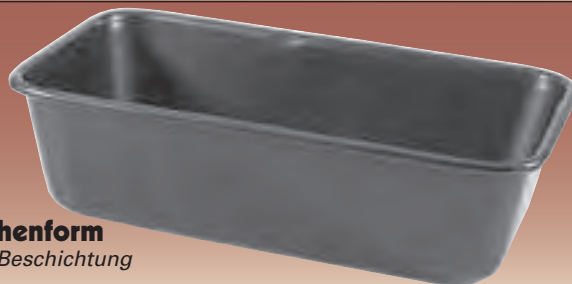
**Königskuchenform**

mit Antihft-Beschichtung

Art.-Nr.	Länge x Breite x Höhe/cm	€/Stück
3123 230	23 x 13 x 7	4,70

**Quadratische Backform**

mit Antihft-Beschichtung

Art.-Nr.	Länge x Breite x Höhe/cm	€/Stück
3126 230	23 x 23 x 3,5	4,90

Back-Fettpinsel mit Vorratsbehälter

Art.-Nr.	Länge/cm	Inhalt/Liter	€/Stück
3380 000	24	0,25	1,40

**Backpinsel**

Art.-Nr.	Breite/cm	€/Stück
3380 040	4,0	0,78
3380 050	5,0	0,88

**Nylon-Backpinsel**

Art.-Nr.	Breite/cm	Länge/cm	€/Stück
3381 050	5,0	22,5	0,66

**Silikon-Backpinsel**

Art.-Nr.	Breite/cm	Länge/cm	€/Stück
3382 180	4,5	18,0	1,90
3382 210	4,5	21,0	2,10
3382 370	4,5	37,0	2,50

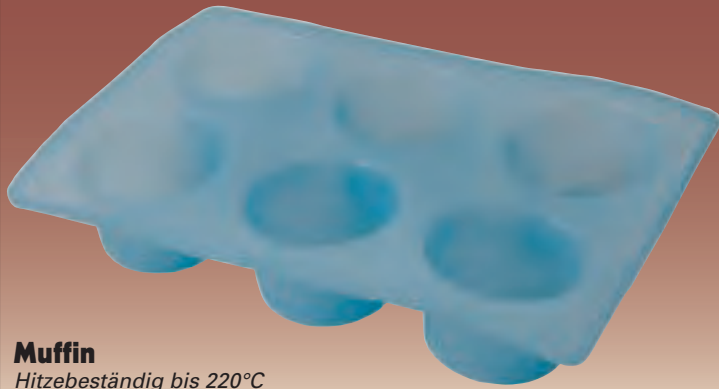

Muffin
Hitzebeständig bis 220°C

Art.-Nr.	Abm./cm	Anzahl	Ø/cm	€/Stück
3160 006	28 x 19 x 4,5	6	6,5	6,90



MUFFIN

Art.-Nr.	Abm./cm	Anzahl	Ø/cm	€/Stück
3160 012	36 x 23,5 x 2,5	12	5,5	5,70



MADELEINE

Art.-Nr.	Abm./cm	Anzahl	€/Stück
3161 012	36 x 20 x 1,6	12	5,70

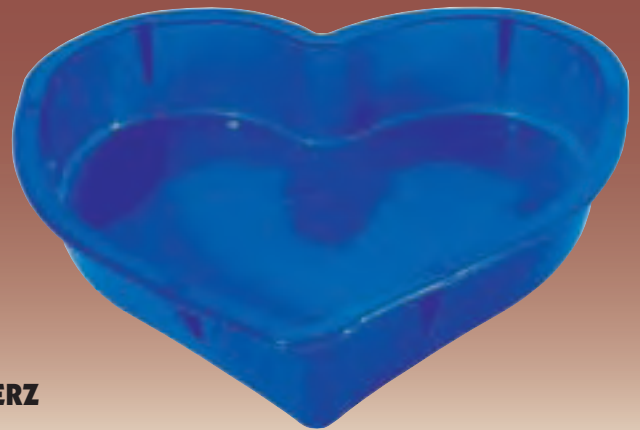

HERZ

Art.-Nr.	Abm./cm	€/Stück
3160 230	23 x 23 x 4	5,90



BUNDFORM

Art.-Nr.	Ø/cm	Höhe/cm	€/Stück
3160 240	24	10	9,00

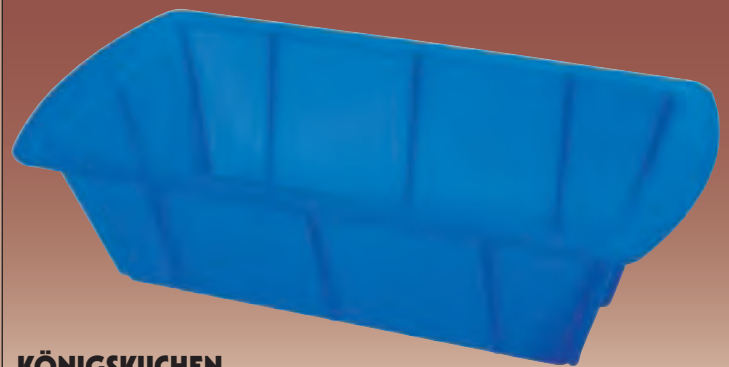

KÖNIGSKUCHEN

Art.-Nr.	Abm./cm	€/Stück
3160 260	26 x 13,5 x 7,5	5,70

BÄR

Art.-Nr.	3160 330
Abm./cm	33 x 28 x 4
€/Stück	9,00

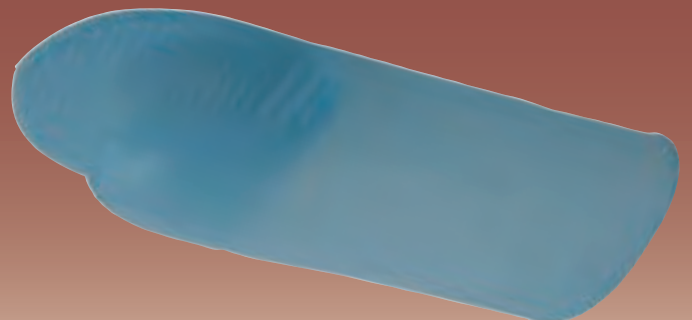

Silikon-Hitzehandschuh
hitzebeständig bis 220°C

Art.-Nr.	Länge/cm	€/Stück
3160 290	29	10,30